

Wooden furniture lock



D-656



GLASS DOOR PLATE

Specifications

- GLASS DOOR PLATE
- TO BE USED WITH A-655 TO SUIT DOUBLE GLASS DOOR LOCK REQUIREMENT
- ZINC ALLOY DIE CAST

A set includes

- 2 PLATES
- 2 SCREWS
- 2 BODY SUPPORTS

Dimensions

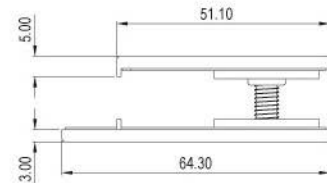
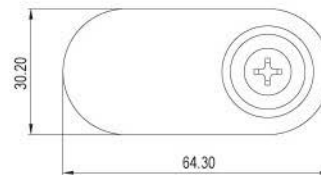
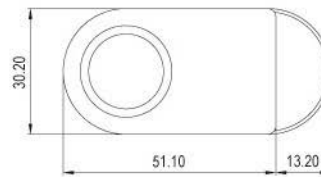

I-064

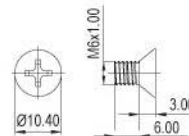

4-7mm GLASS THICKNESS,
USE I-064 SCREW

I-065

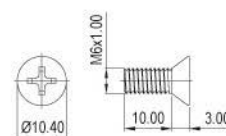

8-11mm GLASS THICKNESS,
USE I-065 SCREW

Wooden furniture lock

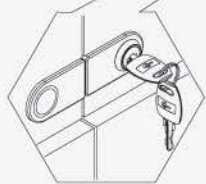
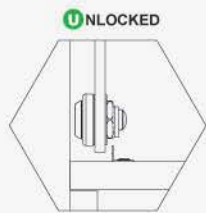
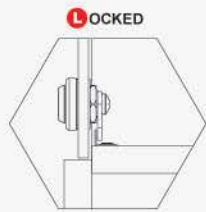

Finished

GLASS DOOR PLATE

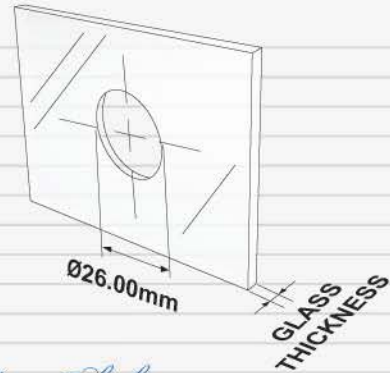

Glass Thickness

4-7mm - USE I-064 SCREW

8-11mm - USE I-065 SCREW

Fixing Details

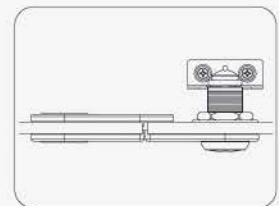
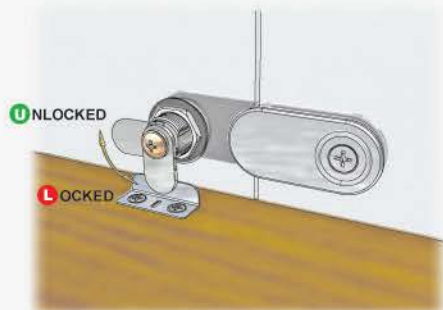

LOCKED

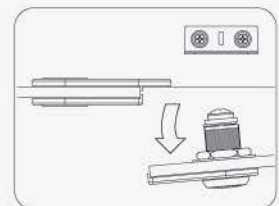

UNLOCKED